

## 2/2-way Angle-Seat Valve with stainless steel design for medium up to +185 °C, DN 15-65



Type 2100 welded can be combined with...



**Type 8691**  
Control Head



**Type 8695**  
Control Head



**Type 8690**  
Pneumatic Control Unit



**Type 8697**  
Pneumatic Control Unit



**Type 8619**  
MultiCELL Transmitter/Controller



**Type 8222**  
Conductivity transmitter

- High flow rates
- High cycle life
- Flow optimised body in stainless steel
- Deliverable with flow direction below or above seat
- Clean design for optimal use in hygienic environment
- Suitable for steam up to 10 bar(g)

In line with Bürkert's philosophy for modular valves and sensors the construction of the 2100 angle-seat valve fulfils tough criteria for process environments. Unrivalled cycle life and sealing integrity is guaranteed by the proven self adjusting spindle packing with V-seals.

The design enables the easy integration of automation modules whether they are electrical/optical position feedback, pneumatic control units, an integrated fieldbus interface.

The fully integrated system has a compact and smooth design, integrated pneumatic lines, IP65/67 protection class and superior chemical resistance.

An explosion-proof version is also available.

Technical data	
<b>Orifice</b>	DN15 to DN65
<b>Port connections</b>	EN ISO 1127/ISO 4200, DIN 11850 S2, ASME BPE, SMS 3008, BS 4825
Welded acc. to	see separate data sheet
Clamp and threaded	
<b>Body material</b>	Stainless steel 316L
EN ISO 1127/ISO4200 and DIN 11850 S2 ASME BPE, SMS 3008 and BS 4825 Part 1	
<b>Nominal pressure</b>	PN25 (Body)
<b>Actuator material</b>	PPS / Stainless steel 1.4561 (316Ti)
Actuator / Cover	
<b>Sealing material</b>	PTFE
<b>Medium</b>	Water, alcohol, oils, fuels, hydraulic fluids, salt solution, alkali solutions, organic solvents, steam, optional fuel gas (EC Gas Appliances Directive 2009/142/EG)
<b>Viscosity</b>	max. 600 mm <sup>2</sup> /s
<b>Spindle packing</b>	PTFE V-rings with spring compensation
<b>Medium temperature</b>	-10 to +185 °C
<b>Ambient temperature</b>	0 to +55 °C (integrated control head) 0 to +60 °C (push-in air ports) 0 to +100 °C (threaded air ports)
<b>Control medium</b>	Neutral gases, air
<b>Max. pilot pressure</b>	max. 10 bar; actuator size 130 mm, 7 bar
<b>Pilot air ports</b>	Push-in connector for external ø 6 mm or 1/4" tube, thread G1/8 (on request)
<b>Installation</b>	As required, preferably with actuator in upright position
<b>Surface Finish</b>	standard Ra, internal ≤ 3.2 µm on request internal connection area <sup>1)</sup> Ra ≤ 0.6 µm mechanical polished (cast iron external surface) internal connection area <sup>1)</sup> Ra ≤ 0.6 µm electro polished (cast iron external surface)

<sup>1)</sup> In the seat area the Ra ≤ 0.6 µm surface finish can be higher.

### Content

Valve specifications		System spec. On/Off ELEMENT		Request for quotation	
Type 2100		Type 8801-YE		Type 8801-YE	
Technical data & ordering info.	p. 1-9	Technical data & ordering info.	p. 10-14		p.16

Technical data angle seat valve Type 2100 flow direction below the seat (for gases and liquids)

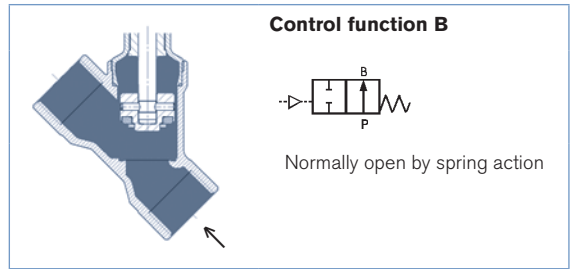
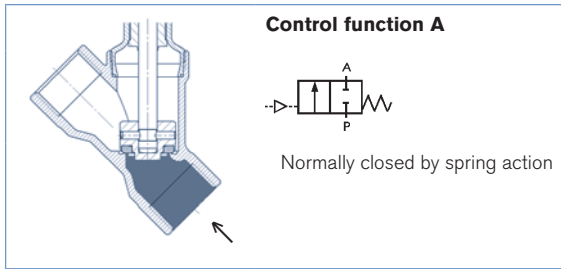

Orifice [mm]	Actuator size [mm]	Kv value water (m³/h)	Minimum pilot pressure CFA [bar]	Operating pressure up to +185°C CFA [bar]	CFB [bar]
15	50	5	5.2	25	16
	70	5	5.0	25	16
20	50	10	5.2	16	16
	70	11	5.0	20	16
25	50	15	5.2	9	14.5
	70	18	5.0	16	16
32	70	27	5.0	8.5	16
	90	28	5.0	16	16
40	70	38	5.0	6	16
	90	40	5.0	16	16
50	70	52	–	–	16
	90	55	5.0	10	16
	130	62	5.0	16	16
65	90	85	5.0	5	14
	130	95	5.6	16 (15*)	16 (15*)

\* acc. to the Pressure Equipment Directive 97/23 / EC for compressible fluids in Group 1 (hazardous gases and vapors in accordance with Article 3, Section 1.3, letter a, first dash)

**Flow rate:** Kv value water [m³/h]: Measured at +20°C, 1 bar pressure at valve inlet and free outlet.

**Pressure valves [bar]:** Overpressure to the atmospheric pressure

Pressure charts with control function B and flow direction below the seat

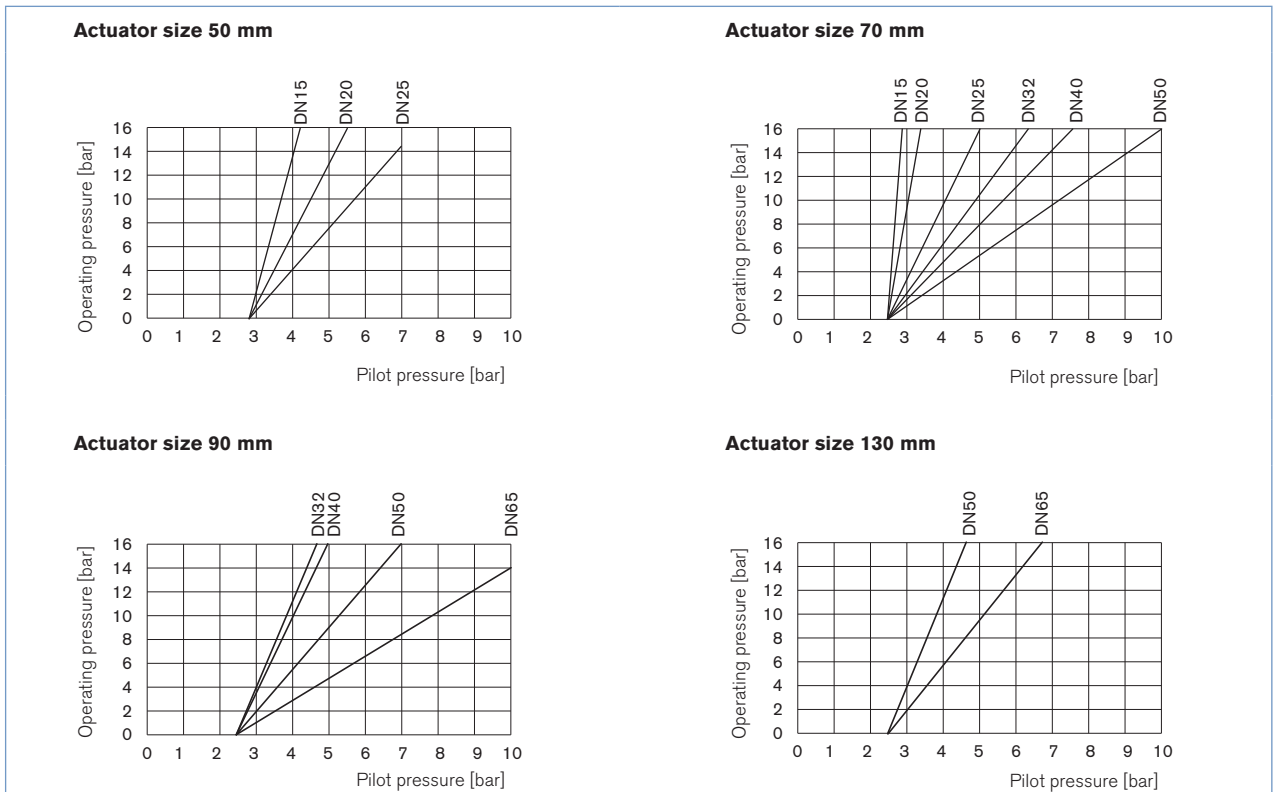

## Ordering chart Type 2100, flow direction below the seat (for gases and liquids)

Weld end acc. to EN ISO 1127/ISO 4200, flow direction below the seat

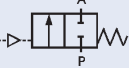
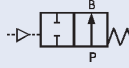
Control function	Orifice (mm)	Actuator size $\phi$ [mm]	Port connection tube $\phi$ [mm]	Minimum pilot pressure [bar]	Operating pressure up to +185°C [bar]	Item no.	Item no. certified Atex II 2GD Mechanical
<b>A</b> 2/2-way valve, NC 	15	50	21.3 x 1.6	5.2	25	187 065	259 581
		70	21.3 x 1.6	5.0	25	188 680	259 582
	20	50	26.9 x 1.6	5.2	16	210 399	259 583
		70	26.9 x 1.6	5.0	20	188 681	259 584
	25	50	33.7 x 2	5.2	9	235 519	260 052
		70	33.7 x 2	5.0	16	188 682	260 053
	32	70	42.4 x 2	5.0	8.5	188 683	260 054
		90	42.4 x 2	5.0	16	188 684	260 055
	40	70	48.3 x 2	5.0	6	188 685	260 056
		90	48.3 x 2	5.0	16	188 686	260 058
	50	90	60.3 x 2	5.0	10	283500	283 502
		130	60.3 x 2	5.0	16	283 501	283 503
	65	90	76.1 x 2.3	5.0	5	239 459	260 061
		130	76.1 x 2.3	5.6	16 (15*)	239 475	260 066
<b>B</b> 2/2-way valve, NO 	15	50	21.3 x 1.6	see chart on p. 2	16	187 069	260 069
		70	21.3 x 1.6		16	188 697	260 074
	20	50	26.9 x 1.6		16	187 070	260 075
		70	26.9 x 1.6		16	188 698	260 085
	25	70	33.7 x 2		16	188 699	260 086
		32	70		42.4 x 2	16	188 700
	40	70	48.3 x 2		16	188 701	260 088
		50	70		60.3 x 2	16	283 504
	65	90	76.1 x 2.3		14	239 467	260 090
		130	76.1 x 2.3		16 (15*)	239 482	260 091

Weld end acc. to DIN 11850 S2, flow direction below the seat

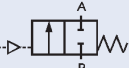
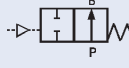
Control function	Orifice (mm)	Actuator size $\phi$ [mm]	Port connection tube $\phi$ [mm]	Minimum pilot pressure [bar]	Operating pressure up to +185°C [bar]	Item no.
<b>A</b> 2/2-way valve, NC 	15	50	19 x 1.5	5.2	25	187 071
		70	19 x 1.5	5.0	25	188 703
	20	50	23 x 1.5	5.2	16	227 605
		70	23 x 1.5	5.0	20	188 704
	25	50	29 x 1.5	5.2	9	227 606
		70	29 x 1.5	5.0	16	188 705
	32	70	35 x 1.5	5.0	8.5	188 706
		90	35 x 1.5	5.0	16	188 707
	40	70	41 x 1.5	5.0	6	188 708
		90	41 x 1.5	5.0	16	188 709
	50	90	53 x 1.5	5.0	10	188 710
		130	53 x 1.5	5.0	16	188 711
	65	90	70.0 x 2.0	5.0	5	239 460
		130	70.0 x 2.0	5.6	16 (15*)	237 020
<b>B</b> 2/2-way valve, NO 	15	50	19 x 1.5	see chart on p. 2	16	187 075
		70	19 x 1.5		16	188 720
	20	50	23 x 1.5		16	187 076
		70	23 x 1.5		16	188 721
	25	70	29 x 1.5		16	188 722
		32	70		35 x 1.5	16
	40	70	41 x 1.5		16	188 724
		50	70		53 x 1.5	16
	65	90	70.0 x 2.0		14	239 468
		130	70.0 x 2.0		16 (15*)	239 483

\* acc. to the Pressure Equipment Directive 97/23 / EC for compressible fluids in Group 1 (hazardous gases and vapors in accordance with Article 3, Section 1.3, letter a, first dash)

 Further versions on request

 Control function  
I (double-acting)

Ordering chart Type 2100, flow direction below the seat (for gases and liquids), *continued*

## Weld end acc. to ASME BPE, flow direction below the seat

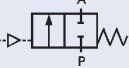
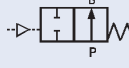
Control function	Orifice (mm)	Actuator size $\phi$ [mm]	Port connection tube $\phi$ [mm]	Minimum pilot pressure [bar]	Operating pressure up to +185°C [bar]	Item no.	
<b>A</b> 2/2-way valve, NC 	15	50	12.7 x 1.65	5.2	25	187 077	
		70	12.7 x 1.65	5.0	25	188 726	
	20	50	19.05 x 1.65	5.2	16	227 607	
		70	19.05 x 1.65	5.0	20	188 727	
	25	50	25.4 x 1.65	5.2	9	227 608	
		70	25.4 x 1.65	5.0	16	188 728	
	40	70	38.1 x 1.65	5.0	6	188 729	
		90	38.1 x 1.65	5.0	16	188 730	
	50	90	50.8 x 1.65	5.0	10	188 731	
		130	50.8 x 1.65	5.0	16	188 732	
	65	90	63.5 x 1.65	5.0	5	239 461	
		130	63.5 x 1.65	5.6	16 (15*)	239 478	
	<b>B</b> 2/2-way valve, NO 	15	50	12.7 x 1.65	see chart on p. 2	16	187 082
			70	12.7 x 1.65		16	188 740
20		50	19.05 x 1.65	16		187 083	
		70	19.05 x 1.65	16		188 741	
25		70	25.4 x 1.65	16		188 742	
		40	70	38.1 x 1.65		16	188 781
50		70	50.8 x 1.65	16		188 744	
		65	90	63.5 x 1.65		14	239 469
			130	63.5 x 1.65		16 (15*)	239 484

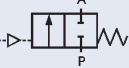
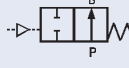

## Weld end acc. to SMS 3008, flow direction below the seat

Control function	Orifice (mm)	Actuator size $\phi$ [mm]	Port connection tube $\phi$ [mm]	Minimum pilot pressure [bar]	Operating pressure up to +185°C [bar]	Item no.	
<b>A</b> 2/2-way valve, NC 	15	50	12 x 1.0	5.2	25	187 084	
		70	12 x 1.0	5.0	25	188 745	
	20	50	18 x 1.0	5.2	16	227 609	
		70	18 x 1.0	5.0	20	188 746	
	25	50	25 x 1.2	5.2	9	227 610	
		70	25 x 1.2	5.0	16	188 747	
	40	70	38 x 1.2	5.0	6	188 748	
		90	38 x 1.2	5.0	16	188 749	
	50	90	51 x 1.2	5.0	10	188 750	
		130	51 x 1.2	5.0	16	188 751	
	65	90	63.5 x 1.65	5.0	5	239 462	
		130	63.5 x 1.65	5.6	16 (15*)	239 477	
	<b>B</b> 2/2-way valve, NO 	15	50	12 x 1.0	see chart on p. 2	16	187 089
			70	12 x 1.0		16	188 759
20		50	18 x 1.0	16		187 090	
		70	18 x 1.0	16		188 760	
25		70	25 x 1.2	16		188 761	
		40	70	38 x 1.2		16	188 762
50		70	51 x 1.2	16		188 763	
		65	90	63.5 x 1.65		14	239 470
			130	63.5 x 1.65		16 (15*)	239 485

\* acc. to the Pressure Equipment Directive 97/23 / EC for compressible fluids in Group 1 (hazardous gases and vapors in accordance with Article 3, Section 1.3, letter a, first dash)

Ordering chart Type 2100, flow direction below the seat (for gases and liquids), *continued*

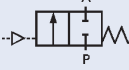
Weld end acc. to BS 4825, flow direction below the seat

Control function	Orifice (mm)	Actuator size $\varnothing$ [mm]	Port connection tube $\varnothing$ [mm]	Minimum pilot pressure [bar]	Operating pressure up to +185°C [bar]	Item no.
<b>A</b> 2/2-way valve, NC 	15	50	12.7 x 1.2	5.2	25	187 091
		70	12.7 x 1.2	5.0	25	188 764
	20	70	19.05 x 1.65	5.0	20	188 765
		70	25.4 x 1.65	5.0	16	188 728
		70	38.1 x 1.65	5.0	6	188 729
		90	38.1 x 1.65	5.0	16	188 730
		90	50.8 x 1.65	5.0	10	188 731
		130	50.8 x 1.65	5.0	16	188 732
		90	63.5 x 1.65	5.0	5	239 461
		130	63.5 x 1.65	5.6	16 (15*)	239 478
<b>B</b> 2/2-way valve, NO 	15	50	12.7 x 1.2	see chart on p. 2	16	187 095
		70	12.7 x 1.2		16	188 778
	20	50	19.05 x 1.65		16	187 096
		70	19.05 x 1.65		16	188 779
	25	70	25.4 x 1.65		16	188 742
		70	38.1 x 1.65		16	188 781
	50	70	50.8 x 1.65		16	188 744
		90	63.5 x 1.65		14	239 469
	130	63.5 x 1.65	16 (15*)		239 484	

\* acc. to the Pressure Equipment Directive 97/23 / EC for compressible fluids in Group 1 (hazardous gases and vapors in accordance with Article 3, Section 1.3, letter a, first dash)

**Technical data angle seat valve Type 2100 flow direction above the seat** (for gases and steam)

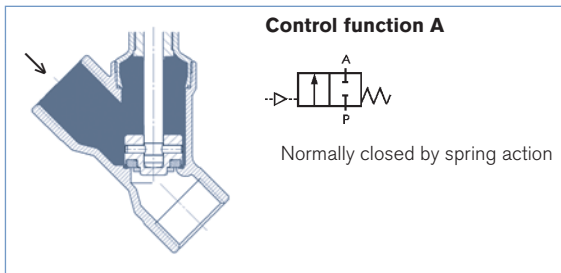

**Attention!**

Valves with flow above the seat are only conditionally usable for liquid medium. There is a danger of waterhammer!

Orifice [mm]	Actuator size [mm]	Kv value water (m³/h)	Operating pressure up to +185°C CFA [bar]
15	50	5	16
	70	5.1	16
20	50	10	16
	70	12	16
25	50	15	16
	70	19	16
32	70	28	16
40	70	38	16
	90	40	16
50	70	50	12
	90	55	16

**Flow rate:** Kv value water [m³/h]: Measured at +20°C, 1 bar pressure at valve inlet and free outlet.

**Pressure valves [bar]:** Overpressure to the atmospheric pressure

**Pressure charts with control function A and flow direction above the seat**

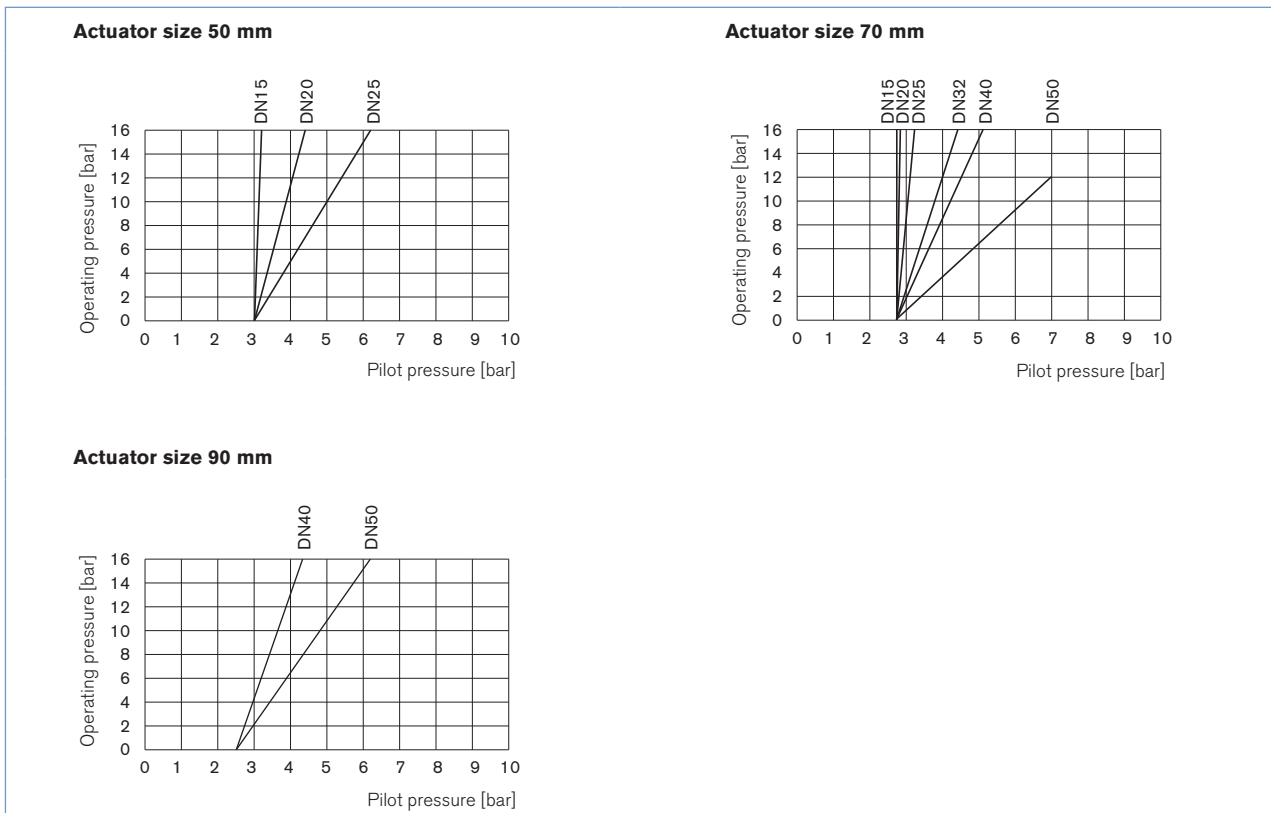

Ordering chart Type 2100 flow direction above the seat (for gases and steam)

Weld end acc. to EN ISO 1127/ISO 4200, flow direction above the seat

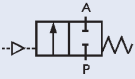
Control function	Orifice (mm)	Actuator size $\varnothing$ [mm]	Port connection tube $\varnothing$ [mm]	Minimum pilot pressure [bar]	Operating pressure up to +185°C [bar]	Item no.
<b>A</b> 2/2-way valve. NC 	15	50	21.3 x 1.6	see chart on p. 6	16	187 066
	20	50	26.9 x 1.6		16	187 067
	25	50	33.7 x 2		16	187 068
	32	70	42.4 x 2		16	188 692
	40	70	48.3 x 2		16	188 693
	50	70	60.3 x 2.0		12	274 663

Weld end acc. to DIN 11850 S2, flow direction above the seat

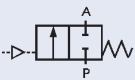
Control function	Orifice (mm)	Actuator size $\varnothing$ [mm]	Port connection tube $\varnothing$ [mm]	Minimum pilot pressure [bar]	Operating pressure up to +185°C [bar]	Item no.
<b>A</b> 2/2-way valve. NC 	15	50	19 x 1.5	see chart on p. 6	16	187 072
	20	50	23 x 1.5		16	187 073
	25	50	29 x 1.5		16	187 074
	32	70	35 x 1.5		16	188 715
	40	70	41 x 1.5		16	188 716
	50	70	53 x 1.5		12	188 718

Weld end acc. to ASME BPE, flow direction above the seat

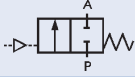
Control function	Orifice (mm)	Actuator size $\varnothing$ [mm]	Port connection tube $\varnothing$ [mm]	Minimum pilot pressure [bar]	Operating pressure up to +185°C [bar]	Item no.
<b>A</b> 2/2-way valve. NC 	15	50	12.7 x 1.65	see chart on p. 6	16	187 078
	20	50	19.05 x 1.65		16	187 079
	25	50	25.4 x 1.65		16	187 080
	40	70	38.1 x 1.65		16	188 736
	50	70	50.8 x 1.65		12	188 738

Weld end acc. to SMS 3008, flow direction above the seat

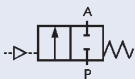
Control function	Orifice (mm)	Actuator size $\varnothing$ [mm]	Port connection tube $\varnothing$ [mm]	Minimum pilot pressure [bar]	Operating pressure up to +185°C [bar]	Item no.
<b>A</b> 2/2-way valve. NC 	15	50	12 x 1.0	see chart on p. 6	16	187 085
	20	50	18 x 1.0		16	187 086
	25	50	25 x 1.2		16	187 087
	40	70	38 x 1.2		16	188 755
	50	70	51 x 1.2		12	188 757

Ordering chart Type 2100 flow direction above the seat (for gases and steam), *continued*

Weld end acc. to BS 4825, flow direction above the seat

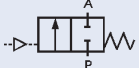
Control function	Orifice (mm)	Actuator size Ø [mm]	Port connection tube Ø [mm]	Minimum pilot pressure [bar]	Operating pressure up to +185°C [bar]	Item no.
<b>A</b> 2/2-way valve. NC 	15	50	12.7 x 1.2	see chart on p. 6	16	187 092
	20	50	19.05 x 1.65		16	187 093
	25	50	25.4 x 1.65		16	187 080
	40	70	38.1 x 1.65		16	188 736
	50	70	50.8 x 1.65		12	188 738

Materials angle seat valve Type 2100

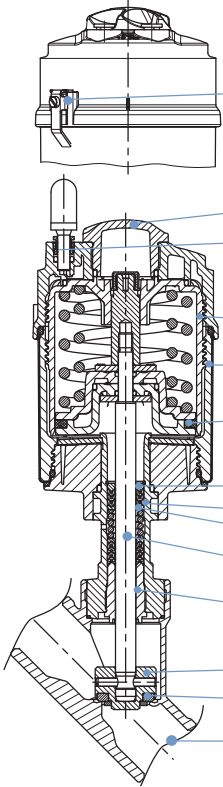
	<b>A</b> <b>Ground terminal</b>	Stainless steel 1.4301/1.4305 <i>Only for the ATEX version</i>
	<b>1</b> <b>Optical position indicator</b>	Transparent cap polysulfone PSU
	<b>2</b> <b>Pilot air ports</b>	Push-in connector PP (standard) <i>On request:</i> Thread G1/8" stainless steel 1.4305
	<b>3</b> <b>Actuator</b>	PPS
	<b>4</b> <b>Cover</b>	Stainless steel 1.4561 (316Ti)
	<b>5</b> <b>Piston seal</b>	FKM
	<b>6</b> <b>Spring</b>	Stainless steel 1.4310
	<b>7</b> <b>Pipe</b>	Stainless steel 1.4401 (316)/1.4404 (316L)
	<b>8</b> <b>Spindle packing</b>	PTFE
	<b>9</b> <b>Spindle</b>	Stainless steel 1.4401 (316)/1.4404 (316L)
	<b>10</b> <b>Spindle guide</b>	PEEK
	<b>11</b> <b>Swivel plate</b>	Stainless steel 1.4401 (316)/1.4404 (316L)
	<b>12</b> <b>Seals</b>	PTFE
	<b>13</b> <b>Valve body</b>	Stainless steel 316L EN ISO 1127/ISO4200 and DIN 11850 S2 ASME BPE, SMS 3008 and BS 4825 Part 1

Lubricants for spindle packing and actuator are classified according NSF H1



Dimensions angle seat valve Type 2100 [mm]

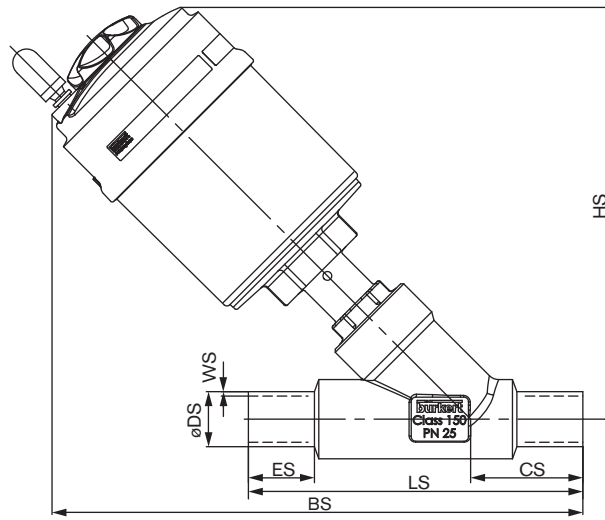

ISO 4200, SMS 3008

All bodies			acc. to ISO 4200							acc. to SMS 3008					
Orifice [mm]	Actuator size [mm]	HS	BS	CS	LS	øDS	ES	WS	BS	CS	LS	øDS	ES	WS	
15	50	163	200	34	100	21.3	20	1.6	212	46	135	12	30	1	
	70	178	216						228						
20	50	171	212	39	115	26.9	25	1.6	225	52	145	18	30	1	
	70	186	228						241						
25	50	172	218	43	130	33.7	30	2	226	51	152	25	30	1.2	
	70	188	234						242						
32	70	197	241	40	145	42.4	26	2	241	40	145	38	26	1.2	
	90	242	283						283						
40	70	201	253	49	160	48.3	30	2	264	60	182	38	30	1.2	
	90	245	296						307						
	130	296	345						356						
50	70	219	273	50	175	60.3	30	2.0	287	64	210	51	30	1.2	
	90	261	312						326						
	130	312	362						376						
65	90	273	324	50	210	76.1	26	2.3	330	56	230	63.5	26	1.65	
	130	324	374						380						

DIN 11850 S2, ASME BPE, BS 4825

All bodies			acc. to DIN 11850 S2							acc. to ASME BPE						acc. to BS 4825					
Orifice [mm]	Actuator size [mm]	HS	BS	CS	LS	øDS	ES	WS	BS	CS	LS	øDS	ES	WS	BS	CS	LS	øDS	ES	WS	
15	50	163	200	34	100	19	20	1.5	200	34	100	12.7	15	1.65	200	34	100	12.7	20	1.2	
	70	178	216						216						216						
20	50	171	212	39	115	23	25	1.5	212	39	115	19.05	25	1.65	212	39	115	19.05	25	1.2	
	70	186	228						228						228						
25	50	172	218	43	130	29	26	1.5	218	43	130	25.4	30	1.65	218	43	130	25.4	30	1.65	
	70	188	234						234						234						
32	70	197	241	40	145	35	26	1.5	-	-	-	-	-	-	-	-	-	-	-	-	
	90	242	283						-						-						
40	70	201	253	49	160	41	26	1.5	253	49	160	38.1	30	1.65	253	49	160	38.1	30	1.65	
	90	245	296						296						296						
	130	296	345						345						345						
50	70	219	273	50	175	53	26	1.5	273	50	175	50.8	30	1.65	273	50	175	50.8	30	1.65	
	90	261	312						312						312						
	130	312	362						362						362						
65	90	273	324	50	210	70	26	2	330	56	230	63.5	26	1.65	330	56	230	63.5	26	1.65	
	130	324	374						380						380						

**2100 welded  
System On/Off  
ELEMENT 8801-YE**

**Ordering information for valve system On/Off ELEMENT Type 8801-YE**

A **valve system On/Off ELEMENT Type 8801-YE** consists of a **angle seat valve Type 2100** and a valve actuation system control head **Type 8691/8695** or a pneumatic control unit **Type 8690/8697** (see separate datasheets).

For the configuration of further valve systems please use the "Request for quotation" on p. 16-17.

You order two components and receive a complete assembled and certified valve.



*A detailed description of the control heads and pneumatic control units is on the next page. →*

Ordering information for valve system On/Off ELEMENT Type 8801-YE, *continued*

Control Head / Feedback



More info.



More info.

**Type 8691**

Actuator size 70/90/130

**Type 8695**

Actuator size 50

The Control Head Type 8691/ 8695 is optimised for integrated mounting on the 21XX process valve series. The registration of the valve end position is done through a contactless analog position sensor, which automatically recognises and saves the valve end position through the Teach function when starting up. The integrated pilot valve controls single or double-acting actuators. The status of the valve is shown through high power coloured LEDs.

**Features**

- High power coloured Status-LEDs
- Contactless inductive position sensor
- Pilot valve with manual override
- Teach function for automatic registration of valve positions
- Hygienic stainless steel design
- Easy to clean chemically resistant housing featuring IP65 / IP67, 4X Rating
- AS-Interface or DeviceNet Fieldbus communication

**Benefits**

- Easy and safe Start-up through Teach function
- Easy process monitoring and error detection through clearly visible high-power coloured LEDs
- High plant availability due to prolonged actuator life boosted by spring chamber ventilation
- Minimised space requirement in the plant piping for more flexibility in plant design

Pneumatic Control Unit / Feedback



More info.



More info.

**Type 8690**

Actuator size 70/90/130

**Type 8697**

Actuator size 50

The pneumatic control unit Type 8697/8690 is optimised for integrated mounting on the 21XX process valve series. Mechanical or inductive limit switches register the position of the valve. The integrated pilot valve controls single or double-acting (8690) actuators.

**Features**

- Visual position indicator
- Mechanical or inductive limit switches for end position registering
- Pilot valve with manual override
- Compact design
- Easy to clean chemically resistant housing featuring IP65 / IP67, 4X Rating
- Optional intrinsically safe version acc. to ATEX

**Benefits**

- Easy and safe Start-up through Teach function (Type 8697)
- High level of signal reliability thanks to self adjusting limit switches
- Minimised space requirement in the plant piping for more flexibility in plant design

Click on the orange box "More info"... you will come to our website for the resp. product where you can download the data sheet.

Dimensions for valve system On/Off ELEMENT Type 8801-YE [mm]

Dimensions valve system On/Off ELEMENT Type 8801-YE-K (with pneumatic control unit Type 8690)

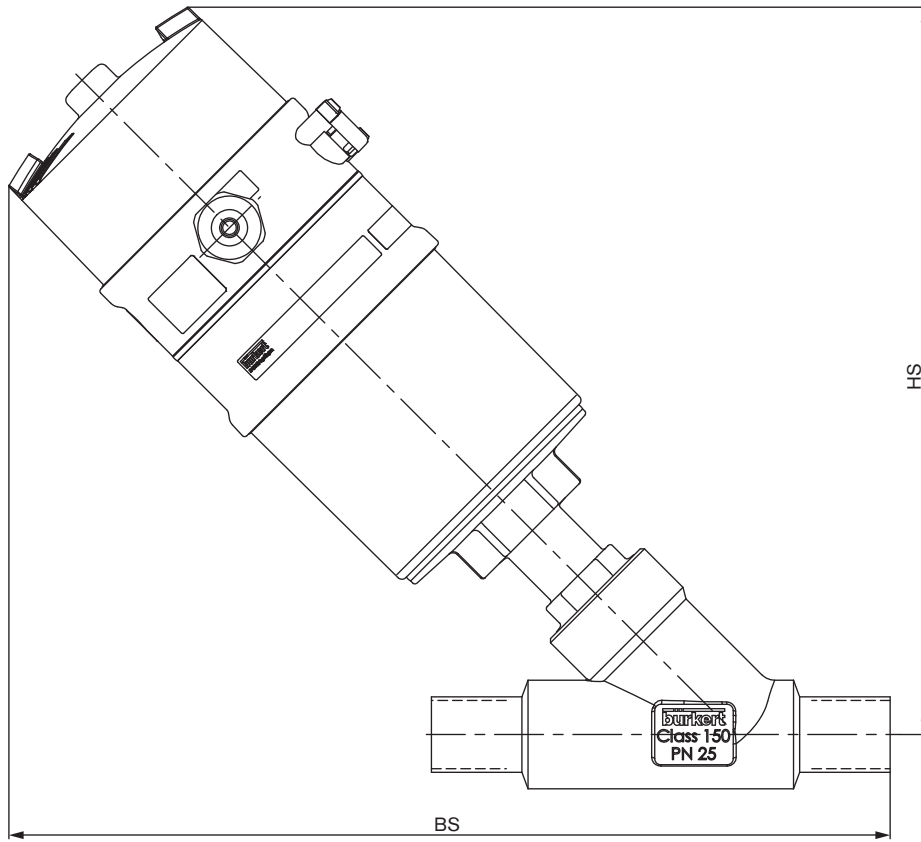

Orifice [mm]	Actuator size [mm]	HS	BS acc. to ISO 4200, DIN 11850 S2, ASME BPE, BS 4825	BS acc. to SMS 3008
15	70	232	270	282
20	70	240	282	295
25	70	242	288	296
32	70	251	295	295
	90	294	335	335
40	70	255	307	318
	90	297	348	359
	130	334	383	394
50	70	273	327	341
	90	313	364	348
	130	350	400	414
65	90	325	376	382
	130	362	412	418

Further dimensions see p. 9

Dimensions for valve system On/Off ELEMENT Type 8801-YE [mm]

Dimensions valve system On/Off ELEMENT Type 8801-YE-K (with pneumatic control unit Type 8697)

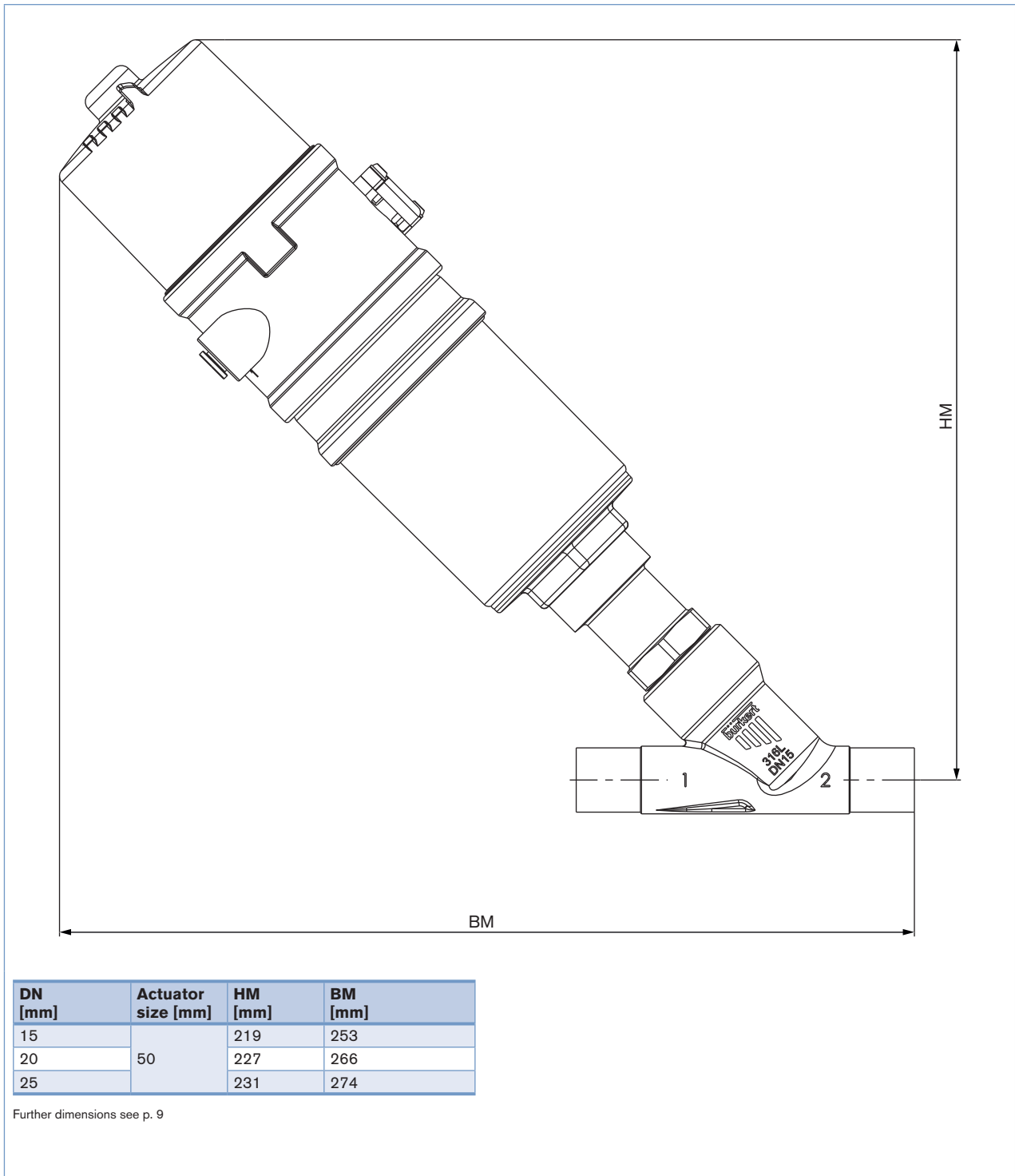

Dimensions for valve system On/Off ELEMENT Type 8801-YE [mm], *continued*

Dimensions valve system On/Off ELEMENT Type 8801-YE-H (with control head Type 8691)

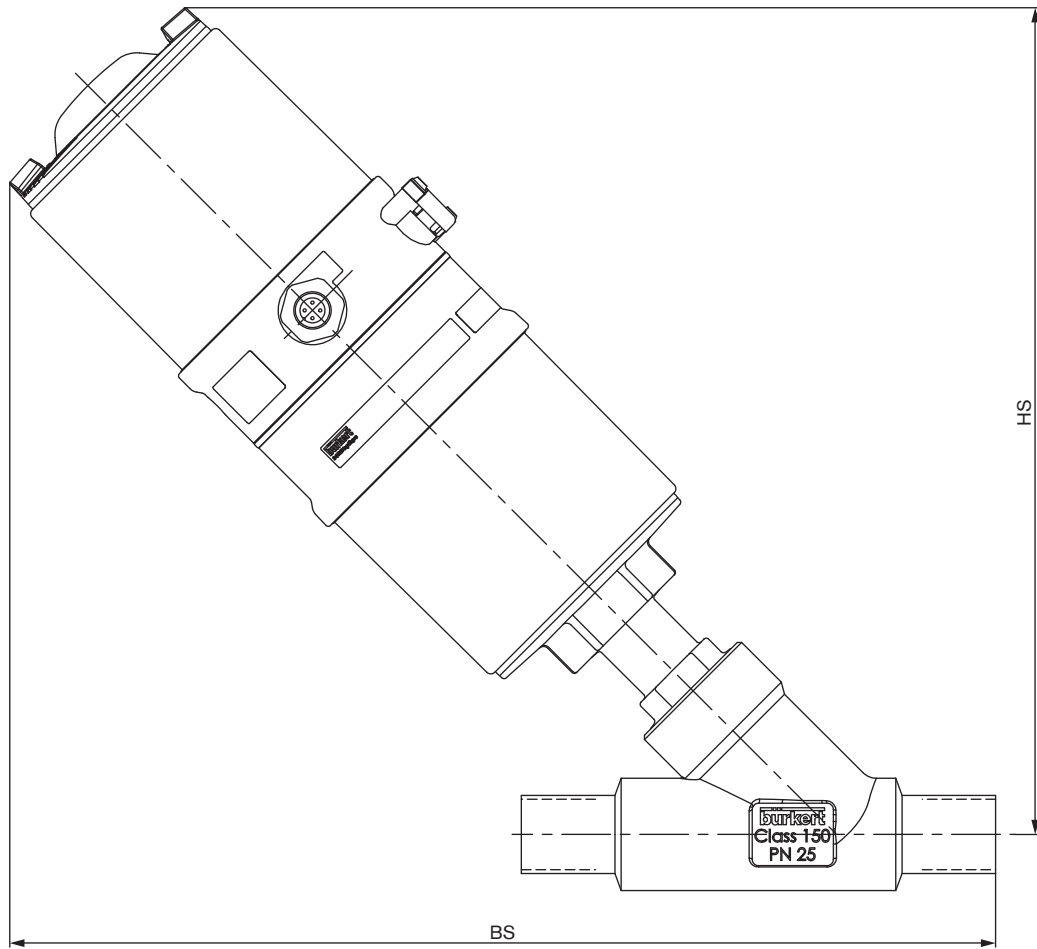

Orifice [mm]	Actuator size [mm]	HS	BS acc. to ISO 4200, DIN 11850 S2, ASME BPE, BS 4825	BS acc. to SMS 3008
15	70	256	294	306
20	70	264	306	319
25	70	266	312	320
32	70	275	319	319
	90	318	359	359
40	70	279	331	342
	90	321	372	383
	130	358	407	418
50	70	297	351	365
	90	337	388	402
	130	374	424	438
65	90	349	400	406
	130	386	436	442

Further dimensions see p. 9

**2100 welded  
System On/Off  
ELEMENT 8801-YE**

**Dimensions for valve system On/Off ELEMENT Type 8801-YE [mm], *continued***

**Dimensions valve system On/Off ELEMENT Type 8801-YE-M (*with control head Type 8695*)**

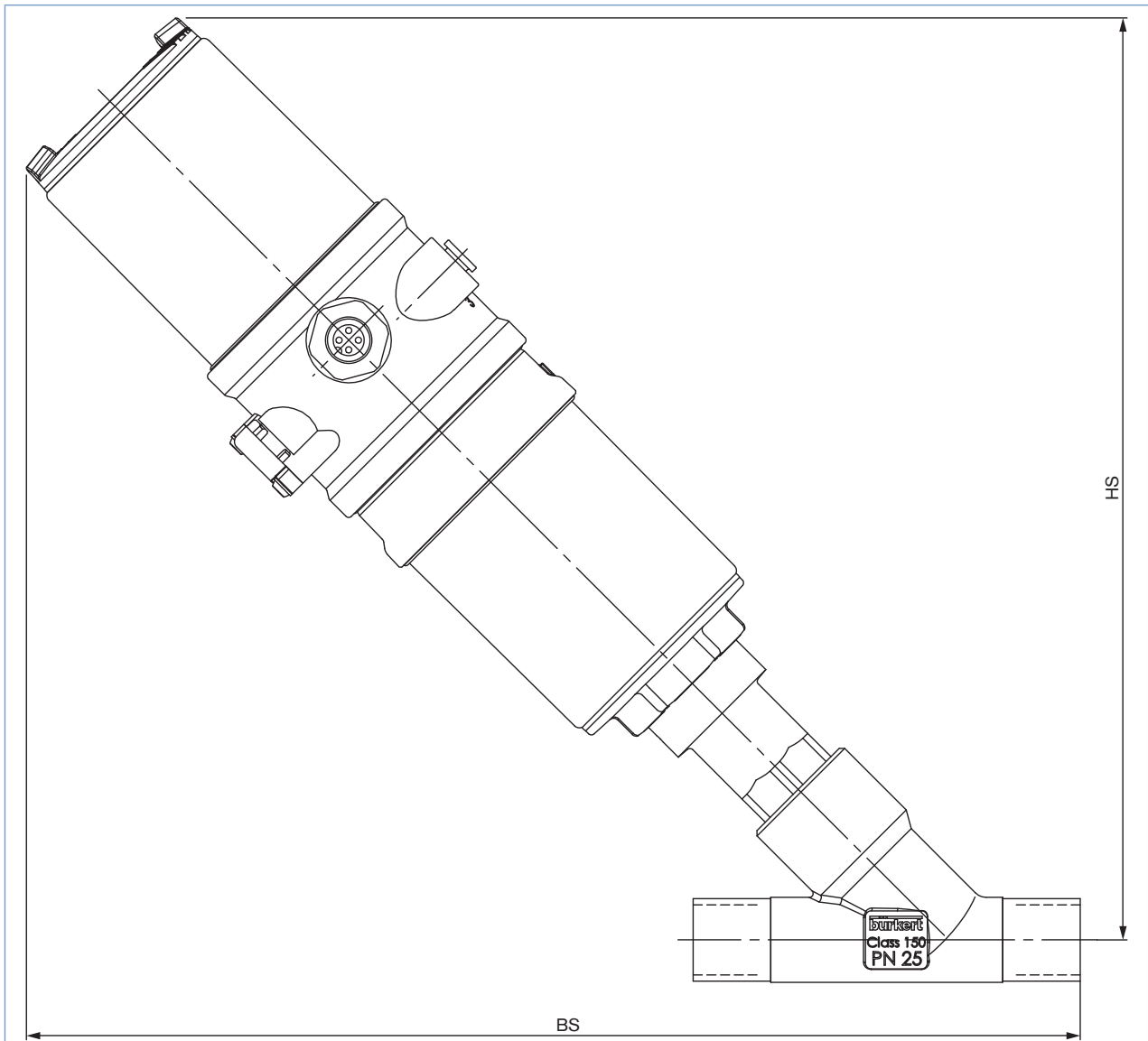

Orifice [mm]	Actuator size [mm]	HS	BS acc. to ISO 4200, DIN 11850 S2, ASME BPE, BS 4825	BS acc. to SMS 3008
15	50	239	276	288
20	50	247	288	301
25	50	248	294	302

Further dimensions see p. 9

**Note**  
You can fill out the fields directly in the PDF file before printing out the form.

**Valve system On/Off ELEMENT Type 8801-YE – request for quotation**

▶ Please fill out and send to your nearest Bürkert facility\* with your inquiry or order

Company	Contact person
Customer no.	Department
Address	Tel./Fax
Postcode/town	E-Mail

= mandatory fields to fill out       Quantity       Required delivery date

**Operating data**

Pipe line DN  PN

Pipe material

Process medium

Type of media     Liquid     Steam     Gas

**Valve features**

Seal material     PTFE     NBR     Other

Nominal pressure PN

Orifice DN

Type of connection     Threaded     Welded     Clamp

Standard connection     ISO     DIN     Other

Control function     NC <sup>1)</sup>     NO <sup>1)</sup>     Double-acting

Pilot pressure  min.     max.

Atex II 2GD Mechanical

Please specify item no. (if known):

<sup>1)</sup>NC: normally closed by spring action; NO: normally open by spring action









Continued on next page →



Valve system On/Off ELEMENT Type 8801-YE – request for quotation, *continued*

**Automation unit features**

Click on the orange box "More info"... you will come to our website for the resp. product where you can download the data sheet.

Control Head / Feedback		Pneumatic Control Unit / Feedback	
<input type="checkbox"/> <b>Type 8691</b>  For actuator size 70/90/130 	<input type="checkbox"/> <b>Type 8695</b>  For actuator size 50 	<input type="checkbox"/> <b>Type 8690</b>  For actuator size 70/90/130 	<input type="checkbox"/> <b>Type 8697</b>  For actuator size 50 
<ul style="list-style-type: none"> <li>Inductive position sensor with automatic Teach function</li> <li>Coloured high power LEDs</li> <li>With/without pilot valve for single or double-acting actuators</li> <li>Fieldbus communication</li> <li>Hygienic stainless steel design</li> </ul>		<ul style="list-style-type: none"> <li>visual status indicator</li> <li>Micro- or proximity switches for end position feedback</li> <li>With/ without pilot valve for single or double-acting actuators</li> <li>Optional intrinsically safe version acc. to ATEX / IECEx</li> </ul>	
<b>Pneumatic function</b> <input type="checkbox"/> Single-acting <input type="checkbox"/> Double-acting <input type="checkbox"/> Without pilot valve	<b>Electrical connection</b> <input type="checkbox"/> Cable gland <input type="checkbox"/> M12 connector	<b>Pneumatic function</b> <input type="checkbox"/> Single-acting <input type="checkbox"/> Double-acting (only with 8690) <input type="checkbox"/> Without pilot valve	<b>Number of Position feedback switches</b> <input type="checkbox"/> 1x <input type="checkbox"/> 2x
<b>Communication</b> <input type="checkbox"/> AS-Interface <input type="checkbox"/> DeviceNet <input type="checkbox"/> without	<b>Approvals</b> <input type="checkbox"/> ATEX cat. 3GD, IECEx <input type="checkbox"/> without	<b>Position feedback switches</b> <input type="checkbox"/> Micro-switch 24V DC <input type="checkbox"/> Micro-switch 50 – 225 V DC/AC (only 8697) <input type="checkbox"/> Inductive switch 3-wire PNP <input type="checkbox"/> Inductive switch 2-wire NAMUR <input type="checkbox"/> Inductive switch 2-wire 24V DC <input type="checkbox"/> without	<b>Electrical connection</b> <input type="checkbox"/> Cable gland <input type="checkbox"/> M12 connector
			<b>Approvals</b> <input type="checkbox"/> ATEX cat. 3GD, IECEx <input type="checkbox"/> ATEX cat. 2DG, IECEx <input type="checkbox"/> without

**Certifications**

- Attestation of compliance with the order EN-ISO 10204 2.1 (Item-No. 440 788)
- Test report EN-ISO 10204 2.2 (Item-No. 803 722)
- Certification of Conformity for Raw Material EN-ISO 10204 3.1 (Included in delivery)
- EN161 (European Gas Device guideline)
- FDA and USP compliance

**Comment /sketch**

To find your nearest Bürkert facility, click on the orange box → [www.burkert.com](http://www.burkert.com)

In case of special application conditions, please consult for advice.

Subject to alteration.  
© Christian Bürkert GmbH & Co. KG

1607/14\_EU-en\_00895156